

# Mobile Phones as Sources of Electromagnetic Interference

Jacek Skrzypczynski, Vesna Roje, Kurt Lamedschwandner, Sinisa Antonijevic, Cecil Stefan

**Abstract:** The paper deals with a problem of interference as a result of the mobile phone coupling into the cabling of a complex system. The phenomenon has been simplified to a problem of near field coupling between a radiating antenna and a wire placed near a metal plate in an open area. Numerical simulations based on Methods of Moments have been performed for various lengths of the wire, for different distance between the wire and the plate, and for three polarizations of the antenna. The results for the voltage induced at the cable termination have been obtained while the antenna has been moving along the full length of the wire. Good agreement of the simulation results obtained by different approaches and different computer codes has been found. The simulation results have been checked experimentally.

**Index terms:** near field, numerical simulations, mobile phones, electromagnetic interference

## I. INTRODUCTION

The rapid growth of the cellular telecommunications has resulted in an increasing number of mobile phones that can be regarded as electromagnetic energy radiation sources. In some circumstances the use of GSM phones in planes, busses or cars, as well as near LAN wiring in buildings, can create such level of interference that quality of service or even safety aspects of complex electronic systems could not be guaranteed.

So obviously the impact of GSM phones on control signal cables of a vehicle could be an important safety matter. To explore this phenomenon a generic problem concerning the antenna/cable coupling in the near field has been formulated within frames of COST 286 project "Electromagnetic Compatibility in Diffused Communication Systems". Joint Technical Action 1 of the project is devoted to studying this problem step by step [1]. The aspect of a wire above a metal plate in an open area has been considered first [2]-[5]. Then an enclosure problem with resonances has been judged. And finally cumulative effect of several sources needs to be pondered. The geometry of a generic problem formulated for the first phase is shown in Fig. 1.

Manuscript received December 12, 2006 and revised April 23, 2007. This research project has been initiated and financially supported by EU COST 286 Action and in part by Ministry of Science and Technology, Croatia, in 2006.

Jacek Skrzypczynski is with Electronics Department, Wrocław University of Technology, Wrocław, Poland (e-mail: jacek@pwr.wroc.pl).

Vesna Roje and Sinisa Antonijevic are with Department of Electronics, University of Split, FESB, Split, Croatia (e-mail: vroje@fesb.hr).

Kurt Lamedschwandner and Cecil Stefan are with Austrian Research Centers GmbH-ARC, Seibersdorf, Austria (e-mail: Kurt.Lamedschwandner@arcs.ac.at).

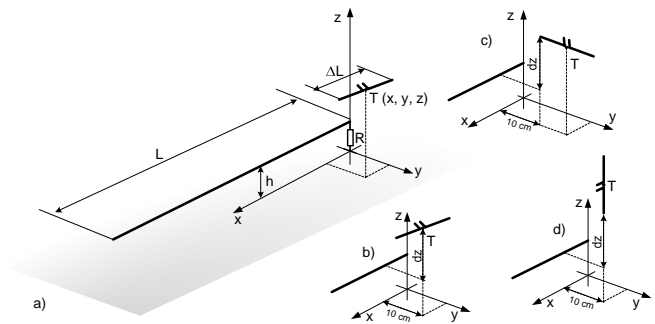

Fig. 1. Schematic diagram of the generic problem: a) the wire over the metal plate; b) the antenna parallel to X axis; c) the antenna parallel to Y axis; d) the antenna parallel to Z axis;  $dz = 10\text{cm}$

The wire of a fixed length is placed at fixed height above a metal plate. A tuned dipole antenna transmitting 900 MHz signal is moving along the wire at a short distance from it. The voltage induced at the wire termination of such configuration was investigated in this paper.

## II. PROBLEM FORMULATION DETAILS

Details of the set-up (Fig. 1) used for both modelling and measurements are as follows:

- The antenna is modelled as a tuned dipole, excited by a 1 Volt, 50 Ohm source;
- 900 MHz frequency is used;
- The wire is symmetrically laid over the metal plate at the height  $h$ ;
- The diameter of the wire is taken as 2mm;
- The metal plate (at  $z=0$ ) may be chosen to be infinite and modelled as a ground plane, or modelled by a grid or another finite metal plate (in the latter case the plate is 3m x 12m);
- The wire is terminated at one end by 150 Ohm and open at the other end;
- The position of the antenna varies as the antenna is moving from  $x=-30\text{cm}$  to  $x=L+30\text{cm}$ ;
- The termination resistance is taken as 100 Ohm + 50 Ohm. The 50 Ohm stands for the input impedance of the measuring receiver;
- The antenna position in Y and Z direction is fixed so that the nearest point of the antenna to the wiring is 10 cm from the wire in y direction

- ( $y=10\text{cm}$ ) and 10 cm above the wire in  $z$  direction ( $z= h+10\text{cm}$ );
- The antenna is operating for three different polarizations: horizontal ( $x$ ), perpendicular ( $y$ ) and vertical ( $z$ ).

Simulation and measurement results are given only for 1m long wire and for the height of 5cm and 80cm. Validating test efforts have been performed using a tuned dipole antenna. The 150 Ohm termination for the Common Mode impedance of the wire at its terminated end was achieved by placing a 100 resistor in series with 50 Ohm input impedance of the measurement receiver.

### III. SIMULATION RESULTS

The generic problem has been modelled independently by three research teams: in Seibersdorf (Austria), Split (Croatia) and Wroclaw (Poland). All teams have solved the problem with Method of Moments [6, 7]. In Split and Wroclaw Numerical Electromagnetic Code (NEC) [8] have been used while in Seibersdorf the Wire Mom Software [9].

The wire and the excitation antenna have been modelled applying thin wire approximation while the metal plate has been modelled as an infinite ground plane. The research teams have used different lengths of modelling segments and different length of the dipole.

#### A. Segment Length Impact

Segment length impact on simulation results was investigated in Split. The effect was very similar and of the same order for all three polarizations and its nature is illustrated in Fig. 2. The influence is not of the great importance and can be distinctly noticed in the vicinity of induced voltage maximum values.

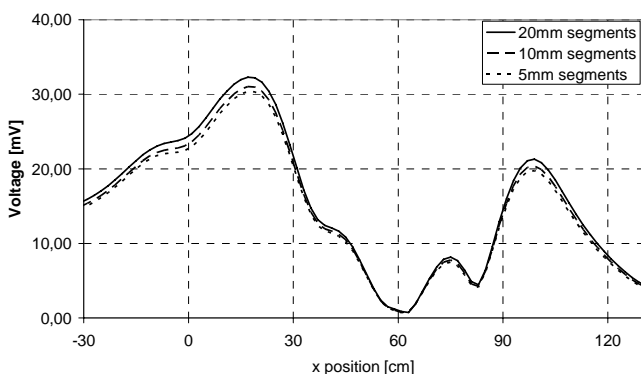

Fig. 2. Comparison of simulation results for three lengths of wire segments: 5mm, 10mm and 20mm; Dipole is parallel to X axis; Wire length 1m, height 80cm

#### B. Dipole Length Effect

It has been found that different codes give different length of the resonant dipole. It has been determined in Wroclaw that 150mm length dipole is in resonance at 900 MHz frequency (minimum of the dipole input impedance imaginary part). The other applied dipole lengths were 155mm in Seibersdorf and 160mm in Split. This led to simulations performed in Seibersdorf to study the impact of dipole length on obtained results. It has been ascertained that for the antenna parallel to X and Y axes the influence is hardly noticeable, while the effect is evident for the antenna parallel to Z axis as it can be seen in Fig.3.

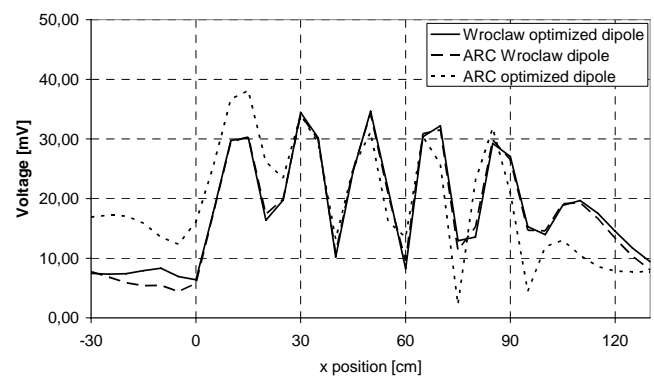

Fig. 3. Comparison of simulation results obtained in Wroclaw (150mm long dipole) with Seibersdorf ARC results calculated for two length of dipole: 150mm and 155mm; Dipole is parallel to Z axis; Wire length 1m, height 5cm

#### C. Influence of Antenna to Wire Distance

The influence of the distance between the antenna and the wire on simulation results was studied in Split. This effect is very important for all polarizations and it is shown in Fig. 4 for the dipole parallel to Y axis. That implies the requirement of very careful distance inspection during a measurement phase of the experiment.

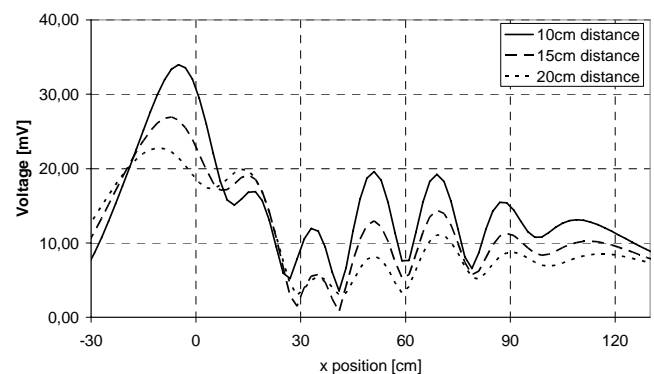

Fig. 4. Comparison of simulation results for different distance between the antenna and the wire (the height of the antenna above the wire: 10cm, 15cm and 20cm); Dipole is parallel to Y axis; Wire length 1m, height 80cm; Segment length 5mm

#### D. Antenna Moving Step Consideration

The simulations were performed in Split with 2cm moving step, in Wroclaw with 1cm or 5cm step, and in Seibersdorf with 5mm or 5cm step. The smaller step is used the more precise depiction of induced voltage is obtained. The 5mm step gives a lot of data what makes time consuming both calculations and measurements. It can be noticed that 5cm step is good enough for the problem investigation as illustrated in Fig. 5.

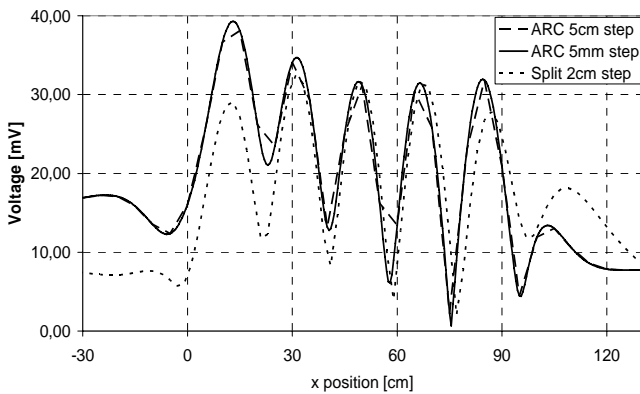

Fig. 5 Simulation results for three computation steps; Dipole is parallel to Z axis; Wire length 1m, height 5cm

#### E. Simulation Results Comparison

Comparison of the simulation results for 5cm height of the wire for x, y and z polarization of the dipole is presented in Fig. 6 and comparison for 80cm height of the wire in Fig. 7.

In spite of differences in modelling procedures the obtained results are quite in a good agreement. The character of voltage changes in the studied generic problem was not much influenced by different simulation methodology. The only exception occurred for z polarization in Seibersdorf simulations, when the influence of the difference in dipole length can not be neglected (as it is reported in the section III.B.). Nevertheless calculated induced voltages had accomplished comparable maximum values.

The antenna parallel to X axis gives two very apparent maximum peaks when it is placed near the wire ends, and minimum values when it is placed near the middle of the wire. The antenna parallel to Y and Z axes gives a few local maximum peaks when it is moved along a wire. The influence of the wire height could be seen through the asymmetry in the results of the induced voltage amplitude (the impact illustrated for 80cm wire height in Fig. 7).

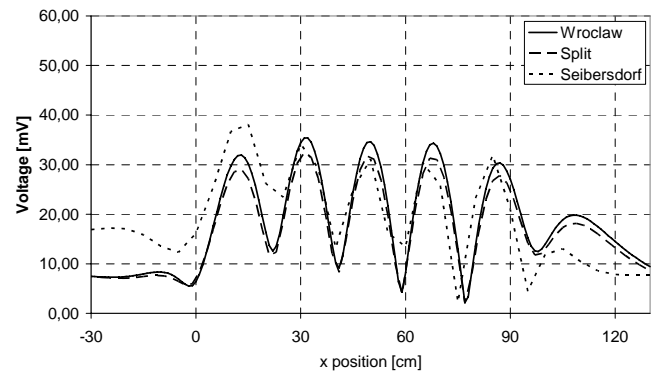
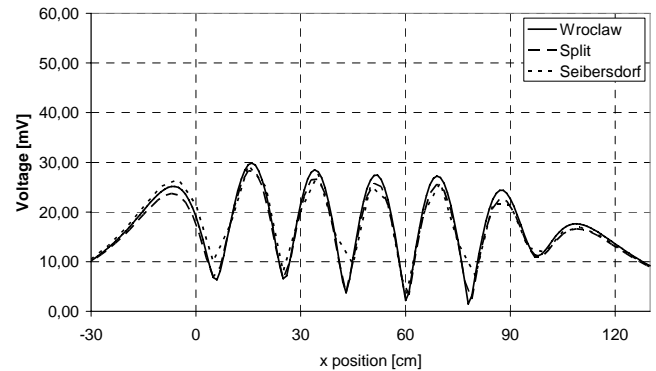
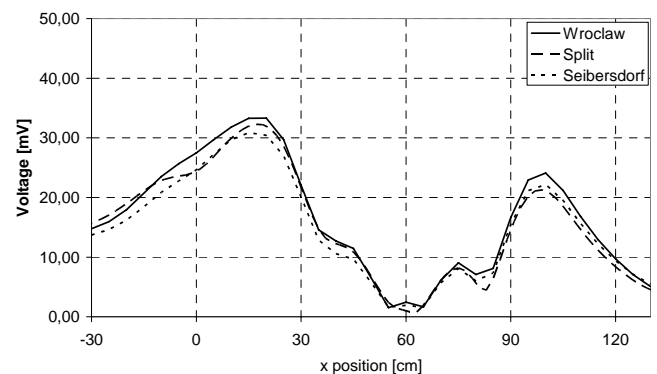

Fig. 6. Comparison of the simulation results for voltage over the 50 Ohm load versus the antenna position; Dipole is parallel to X, Y and Z axes (from top to bottom); Wire length 1m, height 5cm

Simulations of the coupling to the 5m and 10m long wire have been done as well [3], [4], [5], and the similar conclusions have been found out.



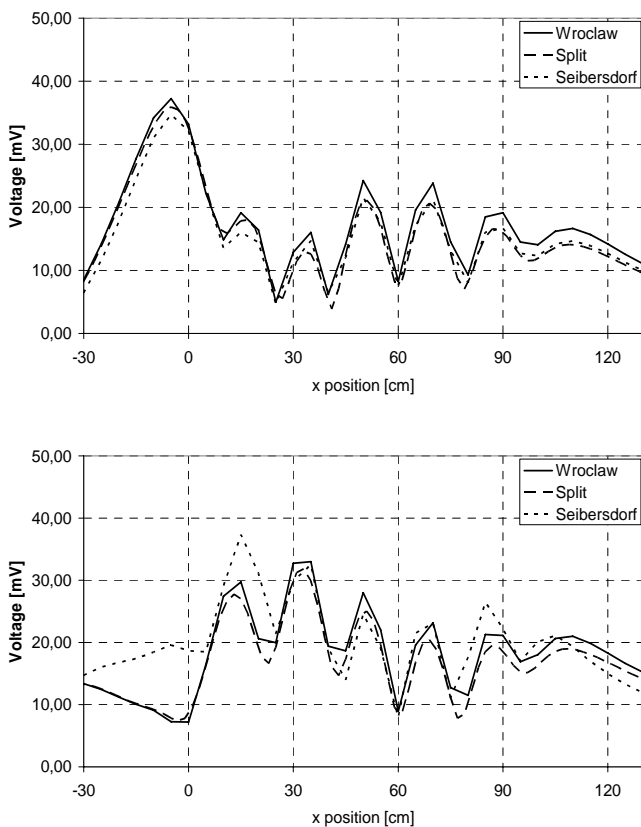

Fig. 7. Comparison of the simulation results for voltage over the 50 Ohm load versus the antenna position; Dipole is parallel to X, Y and Z axes (from top to bottom); Wire length 1m, height 80cm

#### IV. MEASUREMENT RESULTS

##### A. Measurements Done in Split

The measurements performed at the University of Split were organized in a laboratory room that was not screened. Measurement set-up is presented in Fig. 8. The antenna dipole was mounted on relatively long metal arm. The dipole was fed with a coaxial cable through the balun. The metal plate dimensions were 3m x 3m (instead of recommended 3m x 12m).

It was assumed that the experimental verification of the simulation results for one length of the wire and two heights would be satisfactory, so the measurements were performed for (the shortest) 1m long wire and with metal plate close to (at 5cm distance) and far from (at 80cm distance) the wire.

The measurements have been repeated for all three polarizations of the antenna. Results of measurements are presented in Fig. 9. Lack of a good agreement with the simulation results can be observed for a few positions of the antenna especially when it is placed near the loaded end of the wire and the cable connecting the load with the receiver.

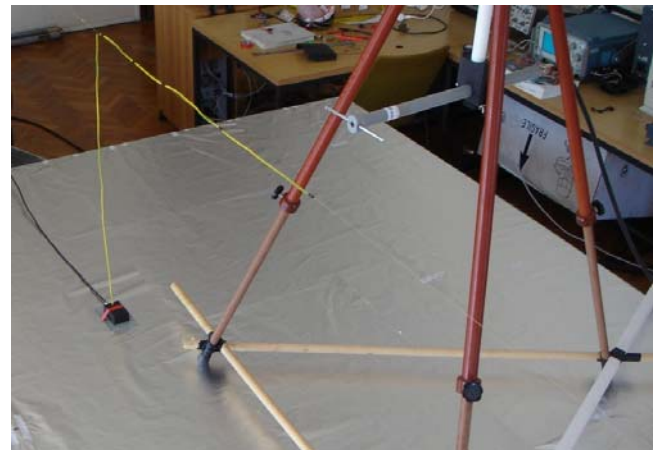

Fig. 8. Measurement set-up configuration in Split

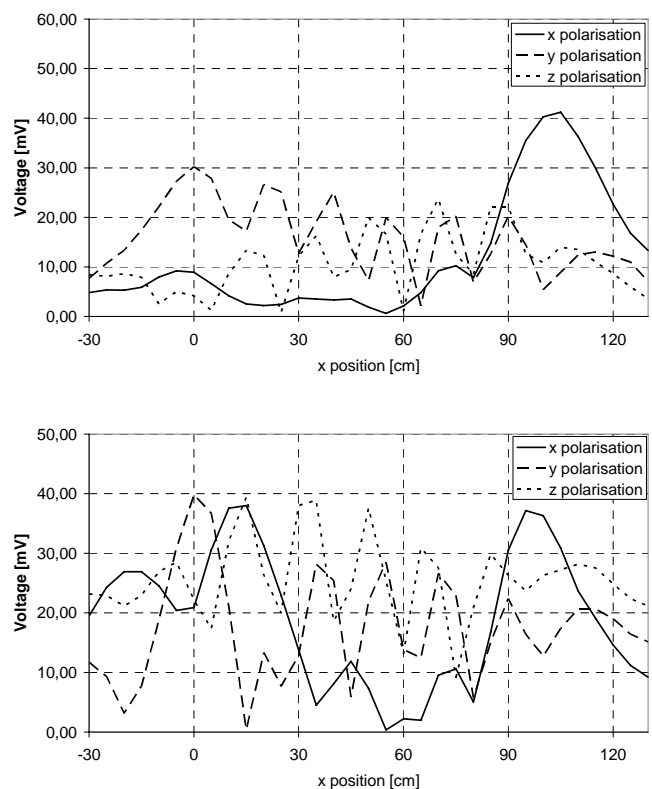

Fig. 9. Results of measurements done in Split; Dipole parallel to X, Y and Z axes; Wire length 1m, height 5cm (top) and 80cm (bottom)

Different techniques of accomplishing connection between the wire load and the cable same as the cable configuration had been investigated. The results are shown in Fig. 10 and Fig. 11.

The comparison of the coaxial cable laid directly on the metal plate with the case when the cable was covered with an aluminium foil is presented in Fig. 10. The results for the cable laid on the plate and covered with metal foil, and for the cable fixed under the plate and connected with the wire through a hole in the metal plate, are given in Fig. 11.

It was found that some changes in measurement set-up configuration could have an effect on the results of measurements.

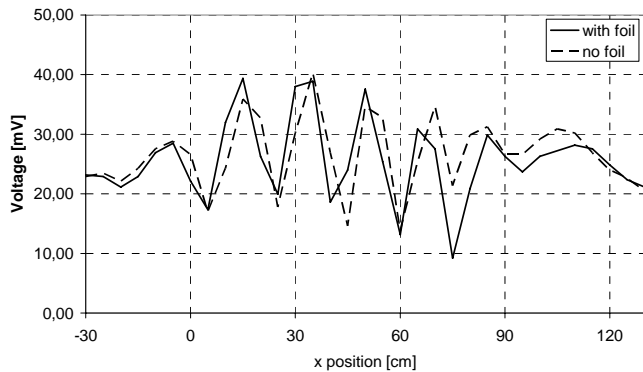

Fig. 10. Results of measurements done in Split; The coaxial cable laid directly on the metal plate compared with the same layout of the cable but covered with a metal foil; Dipole parallel to Z axis; Wire length 1m, height 80cm

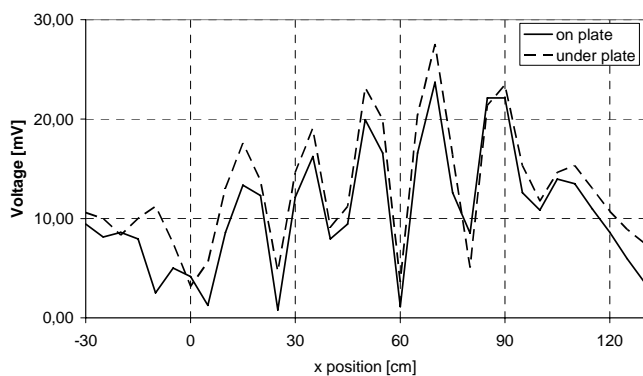

Fig. 11. Results of measurements done in Split; The coaxial cable covered with metal foil compared with the cable put under the metal plate; Dipole parallel to Z axis; Wire length 1m, height 5cm

### B. Measurements Done in Seibersdorf

The measurement set-up used in Seibersdorf (Austrian Research Centers GmbH – ARC) is shown in Fig. 12. The experiment has been completed in an anechoic chamber with use of a metal plate of size 1.5m x 4.3m. The wire configuration was similar to that in Split; the measurements were performed for 1m long wire at 5cm and at 80cm height. The receiver cable was fixed under the metal plate and connected with the loading resistor through a hole in the plate. Precise Reference Dipole PRD was used as an antenna and a ferrite loaded cable was used for connecting it with a generator. PRD with a balun has excellent symmetry (balun balance is specified as better than  $\pm 2$  degrees in phase and  $\pm 0.2$  dB in amplitude) which ensure that there is no current on the shielding of the feed cable and the feed cable does not act as part of the dipole antenna.

Three major components have been considered for calculating the measurement uncertainty: the antenna, the measurement receiver and the measurement cables with

connectors. The uncertainty in the antenna factor of the precision reference dipole is better than  $\pm 0.15$  dB, the uncertainty of the measurement receiver at 900 MHz is specified with  $\pm 0.4$  dB and the error caused by the measurement cables can be estimated with  $\pm 0.2$  dB.

Therefore the overall uncertainty of the Seibersdorf measurements can be assumed with approximately  $\pm 0.5$  dB.

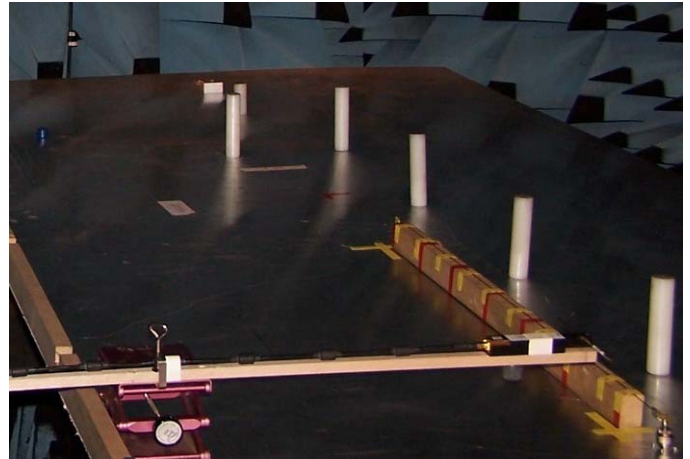

Fig. 12. Seibersdorf measurement set-up configuration

The distance between horizontal part of the wire and the metal plate was fulfilled in three ways. First the wire was mounted on a piece of wood, then on a block of Styrofoam and finally on three small Styrofoam boxes.

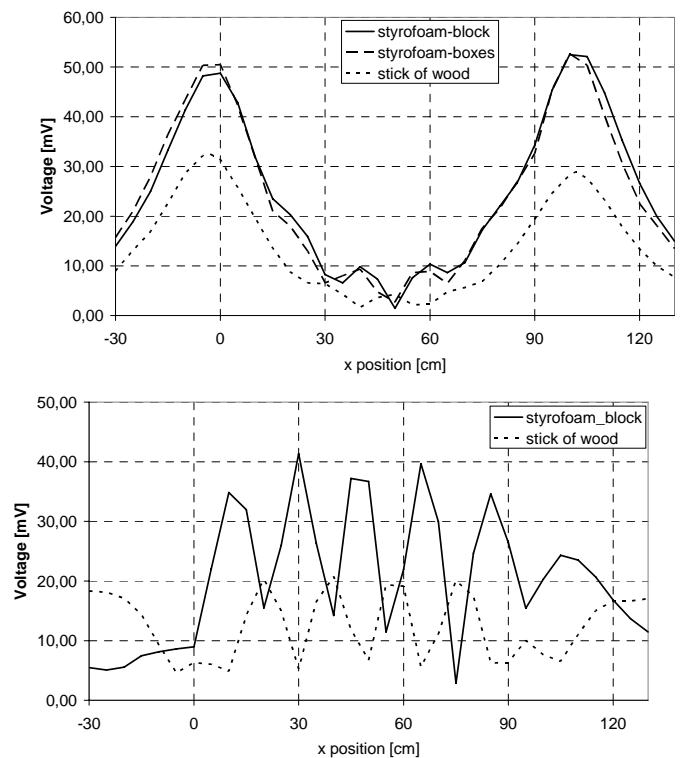

Fig. 13. Results of Seibersdorf measurement done with different supporting material (wood or Styrofoam); Dipole parallel to X (top), and Z (bottom) axes; Wire length 1m, height 5cm

A series of measurements had been conducted with use of Styrofoam support for 5cm height and part wood part Styrofoam support for 80cm height. Results are presented in Fig. 14.

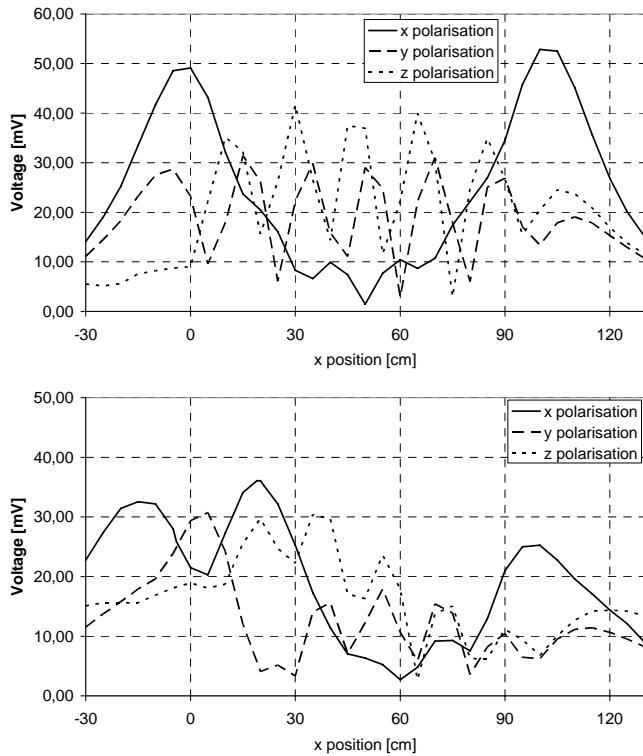

Fig. 14. Seibersdorf measurement results; Dipole parallel to X, Y and Z axes; Wire length 1m, height 5cm (top) and 80cm (bottom)

## V. COMPARISON OF MEASUREMENTS WITH SIMULATIONS

The measurement results obtained for 5cm wire height in both laboratories are compared with Wroclaw simulation results in Fig. 15. The results of Seibersdorf measurement in this configuration are satisfactory for all polarizations of the dipole antenna. Measurements done in Split were best fitted with simulations for y polarization.

The arm of the antenna mounting in Split was relatively large. For y polarization of the antenna the arm was perpendicular to the ground plane (as it can be seen in Fig.17.), while for polarizations x and z it is parallel to the ground (Fig. 8.). This could had caused the lack of a good agreement with simulation for the height of 5cm (very close to the metal plate), especially when the antenna was placed close to the loaded end of the wire. This effect is not present for the height of 80cm as can be noticed looking carefully at Fig. 16, which illustrates comparison of measurements done in Split and Seibersdorf with Split simulation results.

It seems reasonable to suppose that such a big asymmetry in the Split results for x polarization is an error due to factors in setup that could not be completely controlled (the real antenna and the cable were very different to that used in simulations). Although the fact is that the structure is asymmetrical, according to the (all) simulation results it seems that the influence of the loading is not of much importance concerning

the symmetry and the bigger influence of the vertical wire to the symmetry of the results can be noticed only when this wire is becoming longer (30, 80cm height).

Results of 80cm measurements done in Split are higher than simulation results. This discrepancy results from the problem of the uncertainty in precise adjusting the position of the antenna in relation to the wire (the influence of the dipole to wire distance to the induced voltage is significant as it is presented in section III.C.). The mounting of the wire in Split was not very firm in contrast to Seibersdorf set-up. On the other hand the stable pedestal in Seibersdorf has created parasitic effects to measurements, lowering the maximum voltage and changing the maximum voltage distribution.

Differences between measurements and simulations can be judged as not very relevant. They are mostly produced by parasitic effects in measurement set-up. These effects were different in Split and Seibersdorf, for that reason the observed effects were dissimilar too.

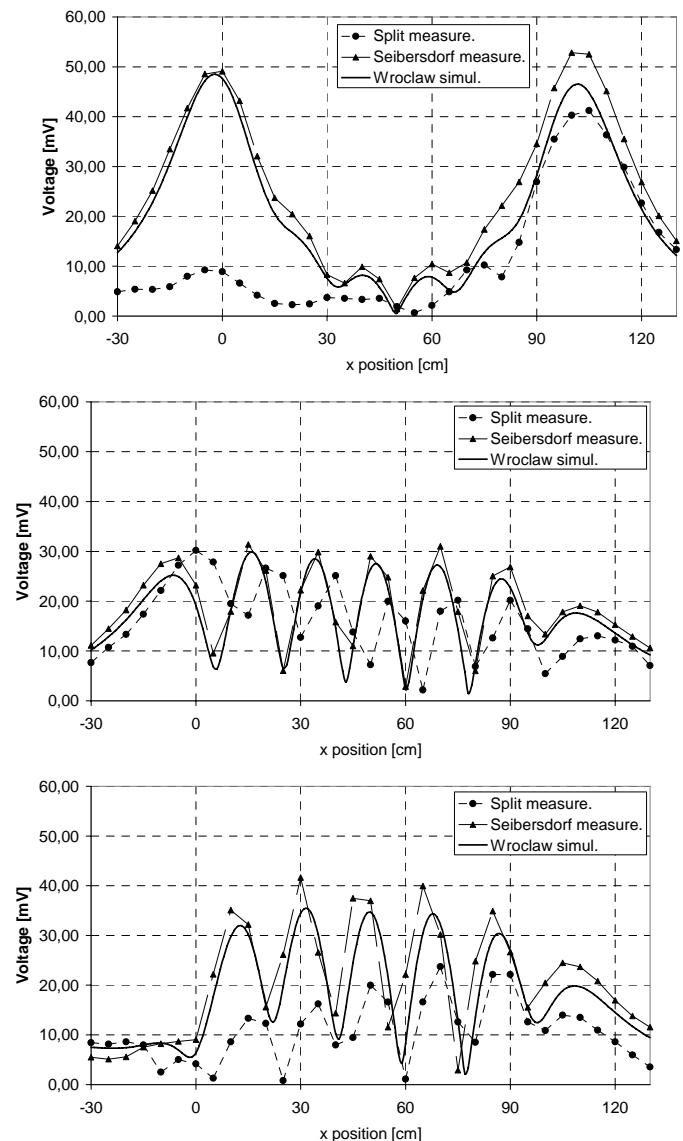

Fig. 15. Results of measurements done in Split and Seibersdorf compared with Wroclaw simulation results; Dipole parallel to X, Y and Z axis (from top to bottom); Height 5cm



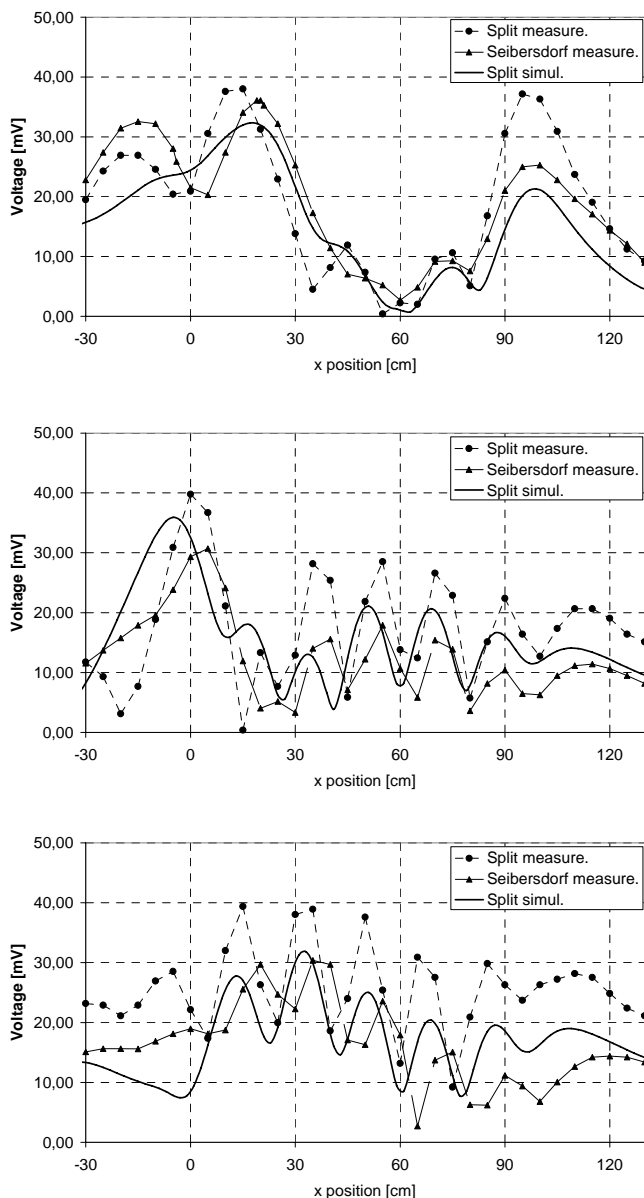

Fig. 16. Results of measurements done in Split and Seibersdorf compared with Split simulation results; Dipole parallel to X, Y and Z axis (from top to bottom); Height 80cm



Fig. 17. The dipole parallel to Y axis in the experiment performed in Split

## VI. CONCLUDING REMARKS

The results obtained for antenna to cable coupling by simulations and by measurements are in a very good agreement.

The character of voltage changes in the studied generic problem was not much influenced by different simulation methodology. The most important factors for a calculated maximum induced voltage are the distances between the antenna and the wire and between the antenna and the metal plate.

It was found that measurement results were influenced by configuration of a cable connection between the wire load and the receiver. It appeared that the experimental results depend on set-up layout. Any metal object in vicinity of the wire or the antenna and any material between the wire and the metal plate could have a direct impact on a maximum induced voltage or on the maximum voltage distribution. The antenna construction itself is of great influence to the measurement results.

The overall uncertainty of the measurements depends rather on the set-up layout than on measurement equipment errors.

Changes in the antenna polarization and height of the wire have limited impact on maximum value of voltage that can be induced across the wire termination (when the distance between the antenna and the wire is kept unchanged).

The calculated and measured maximum value of induced voltage across the 150 Ohm termination is within limits of 15% - 25% of the input antenna voltage in examined antenna/wire configuration

## REFERENCES

- [1] <http://www.emc.york.ac.uk/cost286/JTA.html>.
- [2] C. Christopolos: *Joint Technical Action 1 of COST 286, Report, Cost 286 Workshop, at EMC Europe 2006, Barcelona, Sept. 2006* (prepared for publishing as joint journal paper)
- [3] J. Skrzypczynski: *Report on STSM (JTA1)*, COST 286 Workshop: Impact of Communication Technology to EMC, Split, Dec. 2005
- [4] S. Antonijevic, V. Roje: *Antenna/Wire Coupling in the Near Field, Simulation Results*, COST 286 Workshop, Barcelona, April 2005
- [5] J. Skrzypczynski, V. Roje, S. Antonijevic, K. Staniec: *Simulations and Measurements of Coupling Phenomena Between a Radiating Antenna and a Cable*, EMC Europe 2006, Barcelona, Sept. 2006, pp630-634
- [6] R.F. Harrington: *Field Computation by Moment Methods*, IEEE Press, 1993.
- [7] C. Balanis: *Antenna Theory: Analysis and Design*, Wiley-Interscience, 2005
- [8] G.J. Burke, A.J. Poggio, *Numerical Electromagnetic Code (NEC) – Method of Moments, Part I: Program Description - Theory*, Naval Ocean Systems Center, Technical Document 116, vol.1, July 1977, San Diego, California, USA.
- [9] Carlsson, J.: *Computer code Wire-MoM*, <http://www.sp.se/electronics/RnD/software/eng/default.htm>



**Jacek Skrzypczyński** received the Telecommunication Engineering degree and PhD degree from Wrocław University of Technology (in 1994 and 2003). Since 1994 he has been with Wrocław University of Technology working in the Electromagnetic Compatibility Group. His research interests are primarily in satellite communication, electromagnetic compatibility, antennas and propagation, numerical modelling. He took part in several EMC research projects for government and industry. He has joined three EU EMC actions: COST 243, COST 261 in the past and currently COST 286.

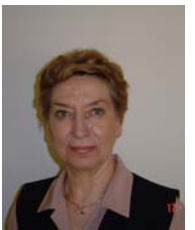

**Vesna Roje** received the B.Sc. (Eng.) degree from the University of Split, Croatia in 1967, and the M.Sc. and the Ph.D. degree (in 1974 and 1983 respectively) from the University of Zagreb, Croatia, all in electrical engineering. Since 1997 she serves as a Full Professor at the Department of Electronics of the University of Split, FESB. Her research interests are in the area of electromagnetic wave theory, antennas and propagation and electromagnetic compatibility, currently focused on electromagnetic interference problems in wireless communication systems. She is founder and chair of the IEEE EMCS Croatia Chapter and Croatia national coordinator of the EU EMC Action COST 286.



**Kurt Lamedschwandner** received his M.S. degree in electrical engineering from the Vienna University of Technology in 1993 and his M.B.A. degree from Webster University Vienna in 2001. He joined the Austrian Research Centers in 1993, where he now is the head of the business field Mobile Communications Safety and of the EMC Test Laboratory. As lecturer at the Vienna University of Technology and at the University of Applied Sciences Technikum Wien he has taught more than 30 courses in EMC and EMF. He is chairman of the Austria Chapter of the IEEE EMC Society and Austrian national representative of COST 286 „EMC”.



**Siniša Antonijević** received B.Sc. degree from the University of Split, Split, Croatia in 2001. He is currently a junior researcher in department of Electronics, University of Split, since December 2001. His research interests include time-domain computational methods in electromagnetics, particularly thin-wire structures transient analysis. To date, he has published nearly 10 conference papers, co-authored 2 book chapters and one book.



**Stefan Cecil**, born 1976 in Eisenstadt, received his M.S. degree in electrical engineering from the Vienna University of Technology in 2003. Since 2004 he is with the Austrian Research Centers where he works as scientist in the business field Mobile Communications Safety. He is working in several projects on problems of electromagnetic compatibility and dosimetry, especially numerical simulations for human exposure to electromagnetic fields.