

Design and Implementation of IP-based RFID Location Systems

Phuoc-Nguyen Tran, Nadia Boukhatem
 Computer Science and Network Department, Telecom ParisTech
 46 rue Barrault, 75013 Paris, France
 {ptran, booukhatem}@telecom-paristech.fr

Abstract— Designing an IP-based RFID system allows low cost deployment and easy integration with IP-based services. In this paper, we propose an IP-based RFID architecture and focus on location management which allows determining “where” the object is after moving. The IP-based RFID architecture includes several components that allow collecting information from RFID infrastructure and updating the current location of RFID tags. A SIP-based implementation is proposed to validate the proposed architecture.

Index Terms—RFID, EPC network, location management

I. INTRODUCTION

Radio Frequency Identification (RFID) landscape has been radically changing since decades. It has been widely deployed by commercial and industrial organizations as well as government agencies with a wide range of applications such as asset tracking, logistics and supply chain management, animal tracking, healthcare, warehouse management, manufacturing engineering, automotive, contactless payments, etc., and mandated by industry giants (e.g., Wall-Mart, Target, Tesco and Albertson, etc.) and various government agencies (e.g., U.S. Department of Defense and Department of Homeland security).

The RFID technology makes it possible to identify an object, to track it and learn its characteristics remotely, thanks to a label emitting radio waves, integrated or attached to the object. The RFID technology enables reading of labels even without direct line of sight and can pass through thin layers of material (paint, snow, etc.).

In the last few years, the RFID systems have evolved significantly in terms of technology and cost, enabling the RFID systems to stand out as the reference identification technology in numerous fields of applications.

One of the main advantages of the RFID technology is to provide a low cost and easy to install indoor location system compared to other positioning systems, such as Global Positioning System (GPS), Wi-Fi, Ultra-Wideband (UWB), Infrared (IR), and sensor based systems.

The material in this paper was presented in part at the 16th International Conference on Software, Telecommunications and Computer Networks (SoftCOM 2008), Split – Dubrovnik, Croatia, Sept. 2008.

The authors are with the Computer Science & Network Department, TELECOM ParisTech, France (e-mail: {ptran, boukhatem}@telecom-paristech.fr).

A number of location sensing systems based on RFID technology have been proposed for indoor location services. SpotON [7] supports indoor location service using RFID technology based on radio signal strength analysis. LANMARC [15] aims at increasing the accuracy in determining the RFID tag location and economizing the deployment cost of the system. FLEXOR [23] is an improvement of LANDMARC to reduce the computational overhead in determining the location of the objects. FERRET [13] allows not only locating the RFID tagged objects, but also displaying the objects using an RFID reader embedded in a camera. In [24], a sensing surface location system is proposed. The system is capable of tracking the objects within a closed environment. When the objects are on the surface, their locations are determined by mapping the RFID tag detected by the RFID readers and the physical surface of the RFID tags that it represents. Besides, some solutions use Wi-Fi based Active RFID tags to expand the coverage zone using the Wi-Fi technology and provide complete wireless asset tracking and monitoring [1] and [4].

Considering the RFID management systems, the EPC global network developed by EPCglobal [6][11][12] is the most representative. EPCglobal aims at standardizing the electronic product code (EPC) and the automatic identification system in the specific context of supply chain.

With the target to develop open RFID management systems and ease the integration of existing network services along with RFID location functionality, a number of works have been proposed.

Recent works investigated the development of open RFID management systems supporting location and tracking functions. Solutions such as Web services technology and SIP based architecture have been proposed (see section III-B).

Our work is motivated by developing an IP-based RFID system management thus enabling low cost and large scale deployment of the RFID technology as well as openness and ease of integration with the existing IP-based services. In particular, a SIP implementation will have the benefit of providing a flexible integration of RFID location with the other corporate network services.

Several motivations underpin our work:

- Propose a SIP-based RFID location system for indoor location. The current location of an object is

determined by the identity of the reader when the object moves under its detection zone.

- Integrate the RFID location services to the other IP services of the corporate network. This provides an integrated and flexible solution.
- More and more communication services such as location based services (LBS) are developed using the location information. The RFID based location system constitutes a good basis for providing such customized services.

The contributions of this paper are as follows:

- Design and specify an IP-based RFID architecture for location management.
- The location service implements two main functions: location and tracking. The location function aims at registering the current location of the RFID objects while the tracking function returns their current location.
- The implementation system defines an interface, which interconnects the RFID system to the existing communication infrastructure and services. With this interface, the location system is notified the RFID objects located in the detection area of the RFID reader, via entering and leaving events.
- The validation of the IP-based RFID location management system using *Session Initiation Protocol (SIP)* [22] is presented.

This paper is organized as follows. Section 2 presents a motivating scenario. Section 3 briefly summarizes background and related works. In section 4, we present IP-based RFID location system, its components and its operation. The system validation based on SIP [22] is provided in section 5. Section 6 concludes this paper with further work.

II. APPLICATION SCENARIO

In this section, we present an application scenario to highlight the motivations of the service location development.

Consider a hospital environment where the staff has a business (or access) card that incorporates an RFID tag. An RFID tag can also be added to any medical equipment (defibrillators, portable scanner, etc.). RFID readers are scattered throughout the grounds of the hospital mainly at strategic locations or crossing such as doors. Doctors may have to move between different departments and buildings and thus among several RFID readers. The latter, through the tracking system, update their current location. If a nurse, for example, seeks to reach a doctor, she can also use the location system to identify where the doctor is. The same goes for finding medical equipment more quickly.

III. BACKGROUND AND RELATED WORKS

A. Positioning systems

A positioning system allows determining the location of an object in space based on real-time collected information. It is also able to track the current location of an object moving

through a space.

GPS system [9][10] is today a widely deployed system. It provides the location of an object on the Earth (e.g., latitude and longitude).

The Wi-Fi positioning system [1][4][10] reuses the existing Wi-Fi infrastructures including the Wi-Fi access points, Wi-Fi-based radio tags integrated in the mobile devices and specific software allowing the system administrators to track the device location and analyze the position accuracy. Although reusing the existing Wi-Fi infrastructure for developing the positioning system economizes the deployment cost, the Wi-Fi network cards and the management system deployment constitutes a non negligible cost.

UWB-based positioning system determines the current location of the object by scanning and continuously monitoring the UWB radio transceivers attached to clients [3][10].

The main advantage of the UWB system is that it can be used at very low energy levels for short-range high-bandwidth communications. The issue is that the battery replacement constitutes a significant cost.

The IR-based system [3] enables to make a real-time tracking but it suffers from some shortcomings. First, it is not able to detect the object without direct line of sight. The IR signal degrades when there is material obstacle because the signal cannot penetrate opaque materials. The IR tags and the IR detectors have to be installed everywhere to avoid losing tracked objects. In addition, the IR system suffers from its sensitiveness to sunlight, direct light of sight requirement, cost of installation and maintenance at large scale.

Similar to most other positioning solutions, sensor-based systems [3] allow determining the location of the objects. The objects (e.g., tags) include a battery-powered radio module that transmits a radio frequency beacon containing a unique identification number. The sensors are installed to receive the radio frequency signal transmitted from the objects. The object location is calculated by using the triangulation method based on the analysis of radio signal strength. However, the obligation of battery integration into the tags limits the sensor network deployment capacities in terms of easy installation and cost.

The RFID technology allows locating the RFID tags attached to object at a close distance that use radio frequency (RF). These tags emit messages readable by RFID readers. Each RFID tag contains a unique identification number. There are two general categories of the RFID tags, active and passive, depending on their source of electrical power. Active RFID tags contain usually their own power source. Passive tags are powered from the signal of the readers. The RFID readers are also categorized into two general types: active and passive. Each type of reader can read specific type of tag [25].

B. RFID Management systems

EPCglobal is an industry-driven organization which aims at standardizing the electronic product code (EPC) and the automatic identification system in the supply chain. The EPC

code stored in the RFID tag allows uniquely identifying a physical object. EPCglobal defines EPCIS (EPC information system) for object identification. The EPCIS includes several components that allow accessing/exchanging information between the enterprises subscribing to the EPCglobal network. However, EPCglobal network is designed as a middleware solution with a specific goal.

While the Internet today is recognized as a network that is fundamentally changing social, political, and economic structures, the trend is that all network technologies converge to IP (Internet Protocol).

The term "Internet of Things" is a new notion that describes a number of technologies and research disciplines that enable the Internet to reach out into the real world of physical objects [8]. Location awareness is also a key feature of the ubiquitous computing, one of the advanced concepts of the Internet of Things. Many initiatives have been launched to develop open RFID based systems supporting location tracking.

The SOA-oriented networked RFID system [28] proposes a decentralized and platform independent location-tracking services using web services technology. The system provides a modular and layered application framework allowing scalability and extensibility.

SIP-based RFID management system (SRMS) [2] uses session initiation protocol (SIP) [22], which is an Internet standard protocol for session initiation to manage the RFID tags. SRMS enhances the existing SIP architecture by introducing a surrogate user agent (SUA) and a SRMS name server (SNS). The SUA performs location registration procedures on behalf of RFID tags with limited capabilities, while the SNS provides name resolution services for location registration and tracking of RFID tags. The RFID-enabled location tracking system (SIP-RLTS) [27] based also on SIP is proposed to support the location management. The SIP-RLTS solution uses the SIP event notification model to support the PUSH and PULL operation needed by the location service.

IV. IP-BASED RFID LOCATION SYSTEM

Our motivation in developing an IP-based RFID system is to allow low cost and large scale deployment of the RFID technology as well as openness and ease of integration with IP-based services. This system should be able to localize the current location of the RFID tags which are attached to various objects, and makes it possible to track the current location of the tags. Each RFID reader is assumed to have an IP address. A tracking node (e.g., computer) can learn the current location of tags by associating the RFID number with the IP address of the reader the tag is attached to.

The system architecture is represented in Figure 1 and includes the following components:

- *RFID Readers and RFID tags:* RFID readers are installed to read information from RFID tags. The readers transmit the obtained information to RFID middleware.
- *RFID middleware* performs the collecting and filtering functions.

- *The RCOM interface* ensures the integration of the RFID system to the communication infrastructure. It notifies that an object enters the reader detection area or leaves it.
- *Location database:* is a database maintaining the current tag's location.
- *Location service* includes two functions: location and tracking. These functions interact with the location database which, in particular, is responsible of inferring the current location of the object when a tracking request is initiated

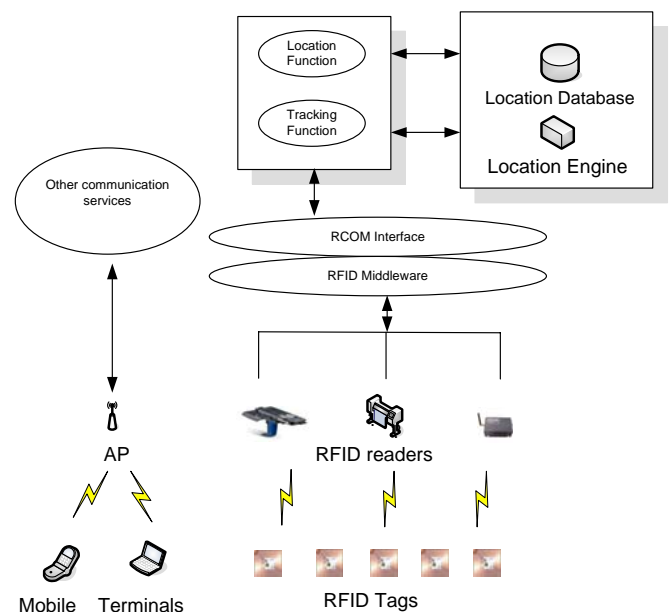

Fig. 1 – Functional Architecture

A. Location Function

As introduced above, the location function aims at indicating the current location of an object. When a tagged object enters the detection zone of the reader, once the collecting and filtering operations are performed by the middleware, the RCOM interface generates a Register-Object message and sends it to the location service (LS) as shown in Figure 2. This message indicates that the object is in the detection zone of the reader. The location function, listening to events generated by RCOM, processes this message, retrieves the current location and updates the location database.

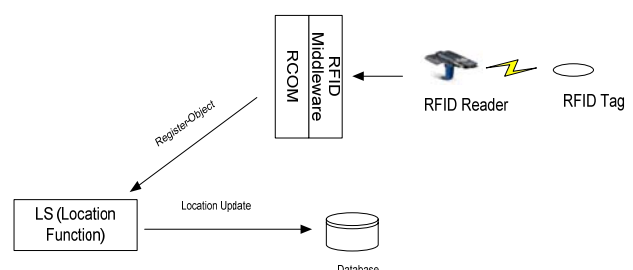

Fig. 2 – Location Function

When a *Register-Object* message is generated by the interface, the location function must update the location database.

In our specification, each record has a lifetime. While the object is under the detection zone of the reader, records are regularly refreshed. However, if the object leaves the detection zone the location function receives a *Deregister-Object* message, a request of de-registration is transmitted

The location function defines two main methods: *Receive-Message()* and *Send-Message()*. When the RFID tag enters or leaves the detection zone of the reader, the events are received by the method *Receive-Message()*. The method *Send-Message()* sends, to the location engine, a message to register or de-register the location. In particular, it defines a message Flag field set to 0 when it is a de-registration.

B. Tracking Function

Following a tracking query, the tracking function solicits the Location Engine. A query of the database allows the tracking function to return the current location of the tag to the location service (see Figure 3).

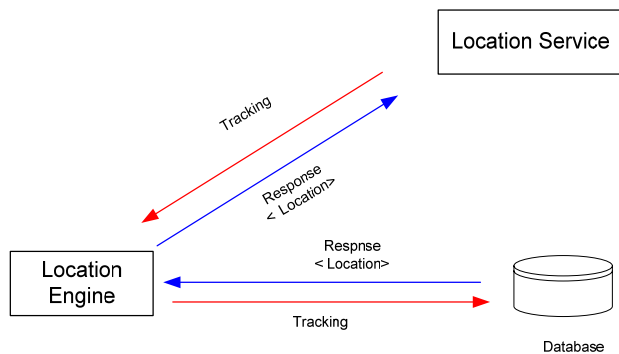

Fig. 3 – Tracking Function

The tracking function is invoked by the location service. It receives arguments of the tag or the name of the object and returns the current location of the object. The tracking function solicits the location engine that queries the location database.

C. The RCOM Interface

In our specification, the functions implemented by the middleware are not presented.

The specification defines two types of messages: *Register-Object* and *Deregister-Object*.

As mentioned previously, *Register-Object* is generated by the interface when an object enters the detection zone of a reader, *Deregister-Object* message is generated when an object leaves the detection zone of a reader. The RCOM message format is shown in Figure 4.

Each message should include the following fields: timestamp indicating the moment of reading the tag, the RFID tag, the type of message (*Register-Object* or *Deregister-Object*) and IP address from which the tag reader is attached.

Timestamp	Tag	Message Type	IP Reader
-----------	-----	--------------	-----------

Fig. 4 – Format of message

V. SIP-BASED RFID LOCATION SYSTEM IMPLEMENTATION

In order to implement the location system specified above we choose to use the session initiation protocol (SIP) for several reasons. SIP allows easy implementation of the RFID based location service. SIP is widely used for VoIP (voice Over IP) services which are today an integral part of the corporate communication infrastructure. Assuming that a VoIP infrastructure is already deployed, our location service can easily be integrated into the infrastructure with a low cost deployment.

A. SIP model overview

The SIP architecture model is based on the concepts of SIP server(s) and SIP user agents (UA). An UA is a software entity that initiates SIP requests (UAC: UA Client) and returns SIP responses (UAS: UA Server). A SIP server can implement one or several of the following functions: *registration, proxy, and redirect*.

A *registration server* or *Registrar* is a server that accepts SIP requests (e.g., SIP REGISTER requests) and the role of which is to register the current location of the UA.

A *proxy server's* role is to route SIP messages. For this purpose, the *proxy server* uses the SIP destination, represented in the form of *URI (Uniform Resource Identifier)*, and the location service to determine the current location of the destination.

A *redirect server* is a server that responds to a SIP INVITE request by sending a 3xx message type to indicate the UA the current location of the destination to reach. Unlike *proxy server*, *redirect server* does not route SIP requests, it indicates to the UA the location it can route the request to.

Note that a UA must register its current location prior to initiate a SIP session.

B. SIP-based location system architecture

The application of the SIP model to the specification described above requires the *RCOM interface* to behave as a SIP UA. A SIP server that performs the Registrar function has to be defined to handle the registration requests initiated by the UA. The SIP server interacts with the location database to record the current location.

To support the tracking function, the SIP server should integrate proxy and redirect functions. The redirect function is used when there is a Tracking request.

The redirect server responds by indicating the current location using a 3xx response type.

The proxy function occurs when the tracked object is managed by other SIP servers.

The system architecture is shown in Figure 5.

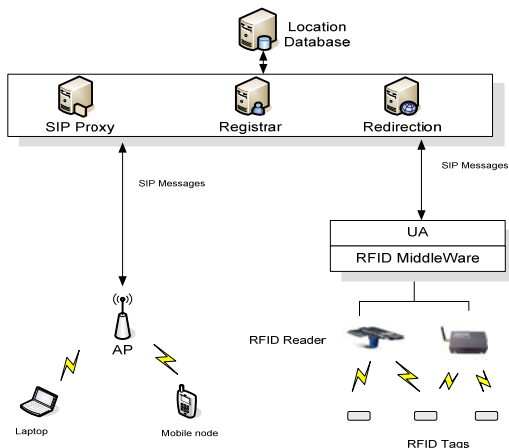

Fig. 5 – SIP-based location system architecture

As shown in the previous section, the location of a tag or object is mainly determined by the IP address of the reader it is attached to.

In the implementation, each RFID tag is associated with a SIP URI (Uniform Resource Identifier) which includes the RFID tag value and the reader's IP address to which this tag is attached. This URI reflects the current location of the RFID tag.

The location database is responsible for managing the information related to the tags and their location.

The location system database defines 4 main tables:

The *RFID-Location-Event* table contains information on the RFID tag and its current network location. This information includes the RFID tag of the object, the IP address of the reader to which the tag is attached, and the timestamp which indicates the instant of detection of the tag object by the reader. An example of this table is given in table 1.

TABLE 1 – RFID-Location-Event table example

Timestamp	RFID Tag	Object	IP Reader
0112200912012030	1a2e3f13ah	Enter	137.194.204.69
0112200913201734	1a2e3f43ed	Enter	137.194.204.69
0112200914012436	1a2e3f13ae	Leave	137.194.200.80
0112200918012445	1a2e4f5e6a	Enter	137.194.203.100

The *RFID-Reader-Location* table contains the geographical location of the RFID reader. This table maintains an association between the geographical location of the RFID reader and its IP address. An example of this table is given in table 2.

TABLE 2 – RFID-Reader-Location table example

IP Reader	Location
137.194.204.69	Room C-208
137.194.200.80	Office 1B
137.194.203.100	Lab. 103

The *RFID-Name* table contains the name of the object (or person) associated with the RFID tag (Table 3).

TABLE 3 – RFID-Name table example

RFID Tag	RFID Name
1a2e3f13ah	Dr. John
1a2e3f43ed	Mr. Smith (Patient)
1a2e3f13ae	Ms. Mary's Laptop
1a2e4f5e6a	Mrs. Rose's cell phone

RFID-DB table (an example given by Table 4) is generated by the Location Server when the tracking system wants to determine the current location of the object. The Location Server combines the various tables depending on whether the tracking service uses the RFID tag or the object name as identity to look for their location. If, for example, the operation of the tracking looks for the geographical location of a given object, the location engine combines the three tables: *RFID-Location-Event*, *RFID-Reader-Location* and *RFID-Name* to generate the current location of the RFID tags in the *RFID-DB* table.

TABLE 4 – RFID-DB table example

RFID Name	RFID Tag	IP Reader	Location
Dr. John	1a2e3f13ah	137.194.204.69	Room C-208

C. Location function - SIP Registration

As mentioned above, the *RCOM interface* integrating the UA indicates the presence of tags in the detection zone of the reader by generating registration requests. *SIP REGISTER* messages are sent to the SIP server. Each *SIP REGISTER* message indicates in its Contact field the RFID tag and the IP address associated to the reader. The SIP server updates the location database. When an RFID tag leaves the area of the reader, a *SIP REGISTER* request with a field "Expires" = 0 is generated.

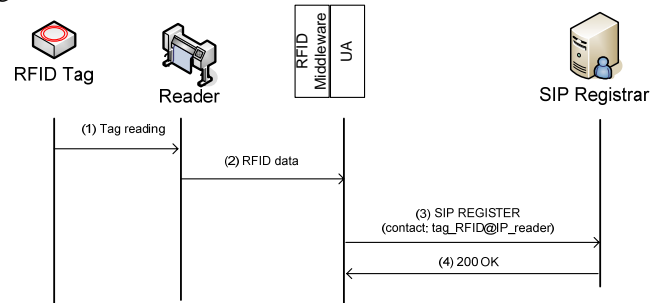

Fig. 6 – Registration procedure

Figure 6 represents the following registration procedure. As an illustration, we assume that an RFID tag is stucked to the business card of Dr. John who is a doctor at hospital A.

- Step 1: When Dr. John arrives in the detection zone of a reader, the RFID tag information including the number of the RFID tag is collected.
- Step 2: The reader transmits the obtained information to RFID middleware that performs filtering and collecting operations.
- Step 3: The *RCOM interface* integrating the UA generates a *SIP REGISTER* message and sends it to the SIP server. The *SIP REGISTER* message contains the *Contact field* in an *URI* form which is the current location of the RFID tag (*tag_RFID@IP_Reader*). The server registers this information at the location database.

- Step 4: If the registration is successful, the registrar generates a *200 OK* message to the UA. We assume, in this example, a registration without authentication. A SIP server configured only for authorized users would generate *407 SIP message* type to request the credentials of the users before accepting the registration.

D. Tracking function - SIP Redirection

To perform the tracking function, we assume that the UA is invoked by a location application which is out of scope of this work.

The UA generates a SIP INVITE message sent to the SIP server. The message contains a SIP URI to indicate the tag or object to locate. The SIP server acts as a redirect server that responds to the INVITE request with a "3xx" message to indicate the current location.

Figure 7 illustrates an example of the tracking procedure. In this example, a nurse wants to know where a specific medical equipment is in the hospital.

The location application generates a SIP INVITE message. The SIP looks for the location of the object by consulting the location database and the redirect function notifies via a "302 Moved Temporarily" message, the current location of the equipment, for example, *equipment_1@office_C208*.

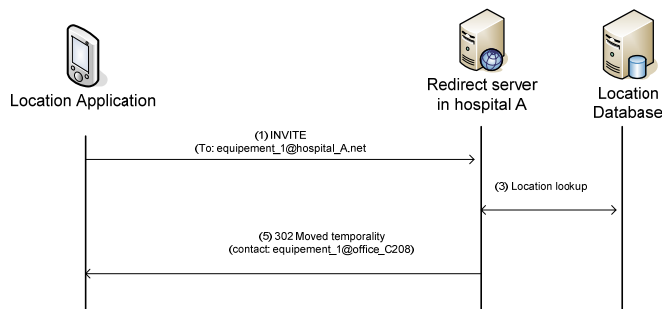

Fig. 7 – Tracking procedure

E. System implementation

The location system is implemented under the Linux operating system and using the C programming language according to an open source GPL license. We implemented the system with some available tools of Linux environment such as PhidgetRFID card libraries and SIP express router (SER).

The PhidgetRFID card [18] is an RFID reader which detects RFID tags that are brought in close of its proximity and returns the tag identification number. The PhidgetRFID reader uses the RFID EM4102 standard [5]. The PhidgetRFID libraries are APIs implemented in C under Linux that allow collecting the RFID tag and returning the unique number contained in the tag.

SIP Express Router (SER) [21] is a high-performance, configurable, open-source GNU licensed server which can act as a SIP (RFC 3261 [22]) registrar, proxy and redirect server. It provides many features of RFC 3261 functionality and a variety of database backends (mysql, oracle, etc.), management features (remote management via XML-RPC), NATi traversal, telephony features (LCR, speed dial), etc.

In our implementation, the backend location database uses my structured query language (MySQL). We develop an UA based on the RFID source code of Phidget. We modified the SER source code so that to be able to receive/send the messages from the UA.

The UA implementation have consisted in developing two events on the PhidgetRFID card for collecting the RFID tags and implementing a Location function to process the registration and tracking requests to the SIP server.

In the following the main implemented functions are described:

```
int Register-Object(CPhidgetRFIDHandle RFID, void *usrptr, unsigned char *TagVal) // An event is issued by Phidget when a new tag is seen by the reader. The event is only fired one time for a new arrival of tag
```

```
int Deregister-Object(CPhidgetRFIDHandle RFID, void *usrptr, unsigned char *TagVal) // An event is issued by Phidget when a tag is out of the coverage zone of the reader.
```

```
char* Create_Request_Line(char *domain) // The request line specifies the type of request being issued by UA (e.g., SIP REGISTER or SIP INVITE), while the response line of SER server indicates the success or failure of a request (e.g., 200 OK, 302 Move temporality, ...).
```

```
char* Create_Contact(char *user_ip, char * user_port, char *user_name) // The contact field contains the current location of object. It indicates the corresponding <RFID tag, IP address of the RFID reader>
```

```
char* Create_Challenge_Register_Body (int seq, char *user_name, char *user_ip, char *user_port, char *domain, char *call_id, char *tag) // This function generates the authentication message. The authentication uses the HTTP Digest method which is documented in [19] and [20].
```

```
char* Create_Auth_Register(char *nonce, int seq, char *user_name, char *user_ip, char *user_port, char *domain, char *call_id, char *tag, char *user_password); // This function generates the authentication response message.
```

VI. CONCLUSION

In this paper, we have proposed an IP-based RFID architecture that allows low cost and large scale deployment, as well as easy integration with IP-based services.

Particularly, a location management support is provided. The RCOM interface is introduced to handle the location registration messages.

A SIP-based architecture and the system implementation have been proposed for validation purpose.

This work is a part of an overall project which aims at developing a global communication network including RFIDs and IP entities to contribute the realization of the future Internet of things

REFERENCES

- [1] Aeroscout solutions – [online] <http://www.aeroscout.com>
- [2] Cho, K. Pack, S. Kwon, T. Choi, Y. (2007), SRMS: SIP-based RFID Management System, *Proceedings of IEEE International Conference on Pervasive Services*, pp. 11-18, ISBN: 1-4244-1325-7, Istanbul (Turkey), 15-20 Jul. 2007.
- [3] Ekahau Whitepaper (2005) - Comparison of Wireless Indoor Positioning Technologies - [online]http://www.productivet.com/docs-2/Wireless_Comparison.pdf
- [4] Ekahau Solutions - [online]<http://www.ekahau.com>
- [5] EM4102 protocol - [online]http://www.ibtechnology.co.uk/PDF/EM4102_DS.pdf
- [6] EPCglobal Website, [online]<http://www.epcglobalinc.org>.
- [7] J. Hightower, C. Vakili, C. Borriello and R. Want (2001), Design and calibration of the SpotON ad-hoc location sensing system, UW CSE 00-02-02, *University of Washington, Department of Computer Science and Engineering*, Seattle, WA, August 2001.
- [8] ITU Internet Report (2005) - The Internet of Things, - [online] http://www.itu.int/dms_pub/itu-s/opb/pol/S-POL-IR.IT-2005-SUM-PDF-E.pdf
- [9] Getting, Ivan A (1993), The Global Positioning System, *In: IEEE Spectrum*, pp. 36 – 37, December 1993.
- [10] Joy, V. Vimal Laxman, P. (2007), Smart Spaces: Indoor Wireless Location Management System, *Proceedings of Next Generation Mobile Applications, Services and Technologies (NGMAST)*, pp. 261-266, ISBN: 978-0-7695-2878-6, Cardiff, 12-14 Sept. 2007.
- [11] Judith M. Myerson (2006), RFID in the Supply Chain: A Guide to Selection and Implementation, ISBN / ASIN: 0849330181, AUERBACH, 20 Nov. 2006
- [12] Klaus F. (2003), RFID Handbook: Fundamentals and Applications in Contactless Smart Cards and Identification, 2nd Edition, ISBN / ASIN: 0470844027, Wiley, 23 May 2003
- [13] X. Liu, M.D. Corner, and P. Shenoy (2006), Ferret: RFID Localization for Pervasive Multimedia, *In P. Dourish, and A. Friday (Eds.), International Conference of Ubiquitous Computing (Ubicomp 2006)*, LNCS 4206, pp. 422-440, 2006.
- [14] Boukhatem, N. Tran, P.N. (2008), IP-based RFID architecture and location management, in *Proceedings of the 16th International Conference on Software, Telecommunications and Computer Networks (SoftCOM)*, pp. 95-99, ISBN: 978-953-6114-97 9, Split (Croatia), 25-27 Sept. 2008.
- [15] L. Ni , Y. Liu , Y. Cho Lau, A. Patil (2004), LANDMARC: Indoor Location Sensing Using Active RFID. *In Wireless Networks 10*, pp.701-710, Kluwer Academic Publishers. Netherlands, 2004.
- [16] Y. Ohta, M. Sugano, and M. Murata (2005), Autonomous Localization Method in
- [17] Wireless Sensor Networks, Proceedings of 3rd IEEE International Conference on Pervasive Computing and Communications Workshops 2005 (PerCom 2005), Kauai Island, USA, 2005.
- [18] PhidgetRFID card - [online] http://www.phidgets.com/products.php?category=14&product_id=1023
- [19] Hypertext Transfer Protocol (HTTP) Digest Authentication Using Authentication and Key Agreement (AKA) - [online] <ftp://ftp.isi.edu/in-notes/rfc3310.txt>
- [20] HTTP Authentication: Basic and Digest Access Authentication - [online] <ftp://ftp.isi.edu/in-notes/rfc2617.txt>
- [21] SIP Express Router - [online] <http://www.iptel.org/ser>
- [22] SIP: Session Initiation Protocol – RFC3261- [online] <http://www.ietf.org/rfc/rfc3261.txt>
- [23] K.L. Sue, C.H. Tsai, and M.H. Lin (2006), FLEXOR: A Flexible Localization Scheme Based on RFID, *In I. Chong, and K. Kawahara (Eds.), International Conference on Information Networking (ICOIN)*, LNCS 3961, pp. 306-316, 2006.
- [24] R. Tesoriero, R. Tebar, J.A. Gallud , M.D. Lozano, V.M.R. Penichet (2009), Improving location awareness in indoor spaces using RFID technology, *In Expert Systems with Applications Journal*, Vol. 37 (2010), pp. 894–898
- [25] Weinstein, R. (2005), RFID: a technical overview and its application to the enterprise, *In: IT Professional*, Volume: 7, Issue: 3, pp. 27- 33, ISSN: 1520-9202, May-June 2005.
- [26] Q. Yang, Y. Chen, J. Yn, and X. Chai (2004), LEAPS: A Location Estimation and Action Prediction System in a Wireless LAN Environment, In H. Jin et al. (Eds.), *IFIP International Conference on Network and Parallel Computing (NPC 2004)*, LNCS 3222, pp. 584-591, 2004.
- [27] Zang, L. Chao-Hsien, C. Wen, Y. (2008), SIP-RLTS: An RFID Location Tracking System Based on SIP, *Proceedings of IEEE International Conference on RFID*, pp. 173-182, Las Vegas (USA), 978-1-4244-1711-7, 16-17 Apr. 2008.
- [28] Zhang T., Xiong Z., Ouyang Y. (2006), A Framework of Networked RFID System Supporting Location Tracking, *Proceedings of the 2nd IEEE/IFIP International Conference in Central Asia on Internet*, ISBN: 1-4244-0543-2, pp. 1-4, Tashkent, Uzbekistan, 19 -21 September 2006.



Phuoc-Nguyen Tran received his undergraduate degree in Electronic and Electrical Engineering from Ho-Chi-Minh City University of Technology (Vietnam) in 2004, and his M.A. in Electronic and Information Technology from University of Paris XI (France) in 2006. He is currently a PhD student at Computer Science & Network of Télécom ParisTech (France). Phuoc-Nguyen is working directly on the 3MING and SUN projects funded by the French National Research Agency (ANR). The SUN (Situating and Ubiquitous Network) research project which aims at defining a global communication network including RFIDs and IP entities. The 3MING (Mobility Multi technology Multi homing) aims at developing solutions for management of multi-homing, He is student member of IEEE.

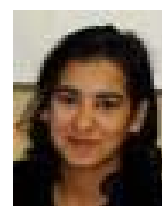

Nadia Boukhatem received her Ph.D degree with honors from the University of Versailles (France), in 1998, in Networks and Computer Science, for her work on the application of agent technology for traffic control in ATM networks. She is currently an associate professor at the Computer Science and Networks Department of Télécom ParisTech (ex. ENST) France since 1999. Her main research interests include network signaling, SLA/SLS negotiation, mobility/multi-homing management. She co-edited the book entitled *Network Control and Engineering for QoS, security and Mobility*, Kluwer academic publishers (Oct. 2002). She has supervised 6 PhD thesis and was involved in several international and national projects. She was a member of the WG 6.7 working group of IFIP technical committee 6.